

**Electricity metering — Part 1: Domestic  
electricity meter enclosures**

**PUBLIC REVIEW DRAFT, FEBRUARY 2013**

**TECHNICAL COMMITTEE REPRESENTATION**

The following organizations were represented on the Technical Committee:

Jomo Kenyatta University of Agriculture and Technology  
Multimedia University  
Rural Electrification Authority  
Kenya Electricity Transmission Company  
Kenya Power and Lighting Company  
Ministry of Public Works  
Ministry of Energy  
Energy Regulatory Commission  
Power Technics Ltd  
Consumer Information Network  
Institute of Engineers of Kenya  
Kenya Electricity Generating Company Ltd  
ABB LTD  
Consumer Federation of Kenya  
National Construction Authority  
Kenya Bureau of Standards — Secretariat

**REVISION OF KENYA STANDARDS**

In order to keep abreast of progress in industry, Kenya standards shall be regularly reviewed. Suggestions for improvement to published standards, addressed to the Managing Director, Kenya Bureau of Standards, are welcome.

© Kenya Bureau of Standards, 2013

*Copyright. Users are reminded that by virtue of Section 25 of the Copyright Act, Cap. 12 of 2001 of the Laws of Kenya, copyright subsists in all Kenya Standards and except as provided under Section 26 of this Act, no Kenya Standard produced by Kenya Bureau of Standards may be reproduced, stored in a retrieval system in any form or transmitted by any means without prior permission in writing from the Managing Director.*

# **Electricity metering — Part 1: Domestic electricity meter enclosures**

## **KENYA BUREAU OF STANDARDS (KEBS)**

**Head Office:** P.O. Box 54974, Nairobi-00200, Tel.: (+254 020) 605490, 69028000, 602350, Mobile: 0722202137/8, 0734600471/2;  
Fax: (+254 020) 604031  
E-Mail: [info@kebs.org](mailto:info@kebs.org), Web:<http://www.kebs.org>

### **KEBS Coast Region**

P.O. Box 99376, Mombasa 80100  
Tel: (+254 041) 229563, 230939/40  
Fax: (+254 041) 229448  
E-mail: [kebs-msa@swiftmombasa.com](mailto:kebs-msa@swiftmombasa.com)

### **KEBS Lake Region**

P.O. Box 2949, Kisumu 40100  
Tel: (+254 057) 23549,22396  
Fax: (+254 057) 21814  
E-mail: [kebs-ksm@swiftkisumu.com](mailto:kebs-ksm@swiftkisumu.com)

### **KEBS North Rift Region**

P.O. Box 2138, Nakuru 20100  
Tel: (+254 051) 210553, 210555

## FOREWORD

This Kenya standard was prepared by the *Switchgear and Distribution Equipment* in accordance with the procedures of the Bureau and is in compliance with Annex 3 of the WTO/TB Agreement.

The objective of this Standard is to provide a meter enclosure that will be acceptable to all supply authorities and home builders, while allowing the existing meters enclosure to co-exist.

In the development of this standard, Australian Standard AS 6002:1999, *Domestic electricity meter enclosures*, was extensively consulted. Assistance derived from this source is hereby acknowledged.

### Normative and informative annexes

A 'normative' annex is an integral part of a standard, whereas an 'informative' annex is only for information and guidance.

### Summary of development

This Kenya Standard, having been prepared by the Switchgear and Distribution Equipment Technical Committee was first approved by the National Standards Council in May 2013	Amendments issued since publication		
	Amd. No.	Date	Text affected

## Contents

1	Scope.....	1
2	Normative references .....	1
3	Definitions.....	1
4	Compliance with specifications .....	1
4.1	General .....	1
4.2	Other requirements.....	1
4.2	Interpretation of specified limiting values .....	2
4.3	New designs and innovations.....	2
5	Design and construction.....	2
5.1	General .....	2
5.2	Construction .....	2
5.3	Materials.....	2
5.4	Enclosure dimensions .....	3
5.5	Earthing.....	3
5.6	Cable access facilities .....	3
5.7	Ventilation and drainage .....	3
5.8	Panel-mounting facilities .....	3
6	Marking.....	4
Annex A (normative) Meter enclosures and panels.....		5



## Electricity metering — Part 1: Domestic electricity meter enclosures

### 1 Scope

This Standard specifies constructional requirements, standard sizes and materials suitable for the construction of electricity meter enclosures for single customers using direct connected metering.

The requirements of this Standard apply to electricity meter enclosures installed to contain the facilities for distributor metering with or without provision for customer switchboard equipment.

### 2 Normative references

The following referenced documents are indispensable for the application of this standard. For dated references, only the edition cited applies. For undated references, the latest edition of the referenced document (including any amendments) applies.

KS 1810, Hot-dip aluminum-zinc plain and corrugated steel sheets - Specification

IEC 60529, Degrees of protection provided by enclosures (IP Code)

KS EAS 124, Rounding off numerical values

KS 662, Kenya wiring regulations (all parts)

KS 02, Specification for galvanized plain and corrugated steel sheets

### 3 Definitions

For the purpose of this Standard, the definitions in KS 662 and those below apply.

#### 3.1 distributor

the supply authority, distribution company or regulatory authority having jurisdiction over the facilities to be provided by the customer for the metering of electricity supplied to that customer.

#### 3.2 meter panel

a panel providing the facilities for the installation of electricity meters which may also include customer switchboard equipment.

#### 3.3 service life

the period of useful life under a specific condition.

### 4 Compliance with specifications

#### 4.1 General

This standard shall be read in conjunction with KS 662.

#### 4.2 Other requirements

Supply authorities and regulatory authorities may have particular requirements which are normally contained in service rules and other documents.

## **4.2 Interpretation of specified limiting values**

For the purposes of assessing compliance with this Standard, the specified limiting values herein shall be interpreted in accordance with the 'rounding method' described in KS EAS 124; that is, the observed or calculated value shall be rounded to the same number of figures as in the specified limiting value and then compared with the specified limiting value. For example, for specified limiting values of 2.5, 2.50 and 2.500, the observed or calculated value would be rounded respectively to the nearest 0.1, 0.01 and 0.001.

## **4.3 New designs and innovations**

Any alternative materials, designs, methods of assembly and procedures that do not comply with specific requirements of this Standard, or are not mentioned in it but give equivalent results to those specified, are not necessarily prohibited. The specific approval remains the prerogative of the relevant regulatory authority or distributor.

# **5 Design and construction**

## **5.1 General**

The meter enclosure shall be designed and constructed in a manner and of materials suitable to provide a service life of not less than 20 years (see Annex A for typical meter enclosures).

## **5.2 Construction**

The meter enclosure shall consist of four sides, a back and a front cover, and all corners shall be square. Provision shall be made for locking facilities. When closed the meter enclosure shall have an IP rating of not less than IP23 in accordance with IEC 60529. Subject to the approval of the relevant distributor, the meter enclosure may have a side-hinged or top-hinged door and may include a viewing panel. The hinges for the door shall be of the 'lift-off' type. For top hinge type, a means shall be provided to prevent inadvertent removal of the door.

The door shall be provided with means to retain the door in both the open and closed positions, as appropriate. The enclosure may be fitted with a latching device that engages automatically to hold the door firmly closed.

## **5.3 Materials**

The materials used in the construction of the meter enclosure shall be non-combustible. Where the material used is sheet steel, the thickness of the steel shall be not less than 1.0 mm. If a galvanized sheet of steel or, hot-dip aluminum–zinc coated sheet of steel is to be used, they shall conform to the requirements of KS 02 and KS 1810 respectively..

When finished in box form, meter enclosure shall—

- (a) be either:
  - (i) coated on the inside and outside surfaces with a material giving a hard, durable finish providing a service life of not less than 20 years; or
  - (ii) have all welds and worked surfaces painted with a good quality corrosive-resistant galvanizing paint or other durable finish, providing a service life of not less than 20 years; and
- (b) be manufactured of compatible materials that are not reactive to each other, or isolated from each other, so as to prevent corrosion from occurring.

NOTE As a safety consideration, the meter boxes should be constructed free of burrs and sharp edges.



**NOTE** To achieve a service life of 20 years, it is vital to consider that under arid/mild conditions of exposure a galvanized coating can be expected to last in excess of 20 years without failure. Where the conditions of exposure are moderate and the coating is not exposed to high levels of industrial or marine fallout, the coatings will normally last in excess of 10 years without failure.

Where heavy industrial and marine fallouts are to be expected, galvanized coatings should be top-coated with a paint that is appropriate for the conditions of exposure.

**5.4 Enclosure dimensions**

The dimensions for the enclosure, covered by this Standard, shall be as specified in Appendix A. The openings in brickwork and dimensions required to accommodate the enclosure shall be in accordance with Table 1.

There shall be a minimum clearance of 180 mm in front of the panel. The minimum clearance behind the panel shall be in accordance with the requirements of KS 662 for hinged switchboard panels.

Any mechanical strengthening used within the enclosure shall not in any way reduce the required minimum internal dimensions.

**5.5 Earthing**

Where the enclosure is made from metal, a non-corroding earth stud, not less than M5 x 20, or the equivalent earthing facilities, complying with the requirements of KS 662, shall be affixed to the body of the enclosure. The enclosure shall be located such that it is readily accessible but does not interfere with the installation, operation, maintenance or removal of metering equipment.

**5.6 Cable access facilities**

Cable access facilities shall be provided and shall be so designed as to maintain their compliance with IP23, in accordance with the requirements of IEC 60529, and shall comply with the requirements of KS 662 for the protection of cables against abrasion and close fitting apertures in the enclosure, for the full service life of the enclosure.

**5.7 Ventilation and drainage**

The enclosure shall be ventilated in a manner that will prevent condensation. This ventilation may be achieved by the clearance between the door and the body. Provision shall be made for draining moisture that might collect in the enclosure.

**5.8 Panel-mounting facilities**

Facilities shall be provided to enable the installation, within the enclosure, of standard meter panels. (Refer Table A.2.) These facilities should be hinged to allow for access to the rear of the mounting panel.

**Table 1 — Dimensions for openings by brick length and courses**

<b>Number of bricks per course</b>	<b>Wall length</b>	<b>Opening size</b>	<b>Number of courses</b>	<b>Height of brickwork</b>
	<b>mm</b>	<b>mm</b>		<b>mm</b>
1	230	250	1	86
1-½	350	370	2	172
2	470	490	3	257
2-½	590	610	4	343
3	710	730	5	429
3-½	830	850	6	514
4	950	970	7	600
4-½	1070	1090	8	686
5	1190	1210	9	772

5-½	1310	1330	10	857
6	1430	1450	11	943
6-½	1550	1570	12	1029
7	1670	1690	13	1114
7-½	1790	1810	14	1200
8	1910	1930	15	1286
8-½	2030	2050	16	1372

## 6 Marking

Where compliance with the requirements of this Standard is claimed by the manufacturer, the meter enclosure shall be clearly and indelibly marked with the following:

- (a) The name, trademark or other means of identification of the manufacturer or of the responsible vendor.
- (b) IP classification.
- (c) The number of this Standard, KS 1068-1.
- (d) Manufacturer's type reference.

NOTE Manufacturers making a statement of compliance with this Kenyan Standard on a product, packaging, or promotional material related to that product are advised to ensure that such compliance is capable of being verified.

**Annex A**  
(normative)

**Meter enclosures and panels**

A typical meter enclosure and panel is shown in Figure A.1 and the panel's typical dimensions are provided in Table A.2.

The external dimensions of each enclosure type are shown in Figure A.2. All dimensions stated have a tolerance of  $\pm 5$  mm.

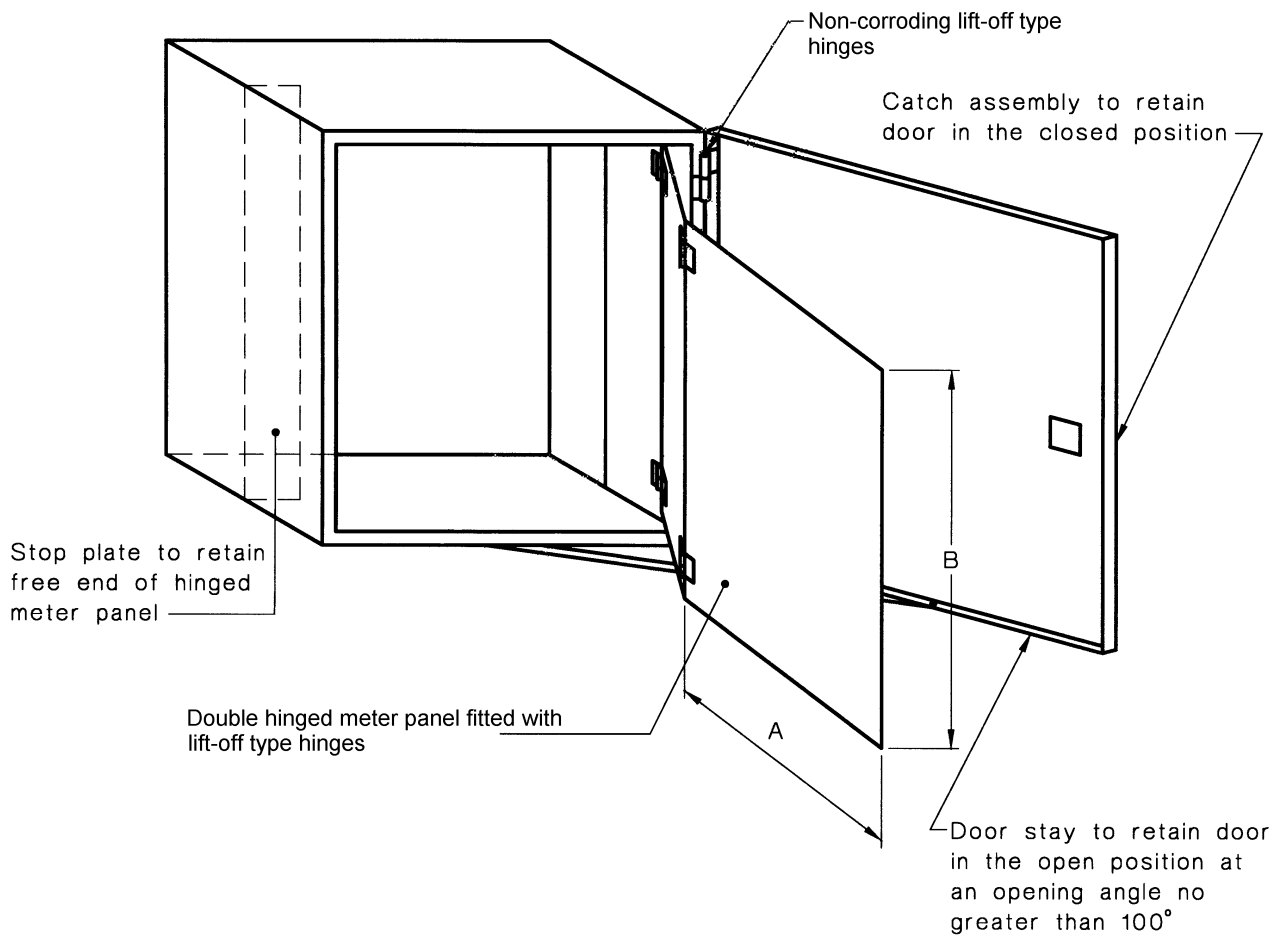

Dimensions in millimetres

**Figure A.1 — Typical meter enclosure and panel**

**Table A.2 — Typical dimensions of meter panels**

Standard meter panel dimensions	
A	B
400	380
460	480
400	590
560	545
600	600

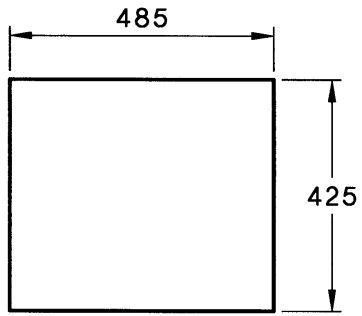

Front elevation

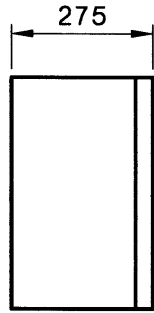

End elevation

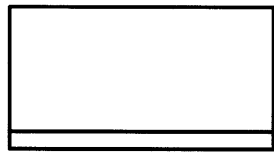

Plan

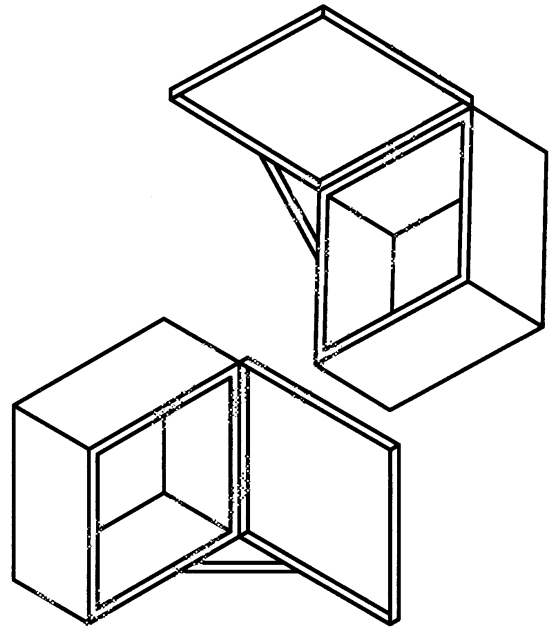

(a) Type I

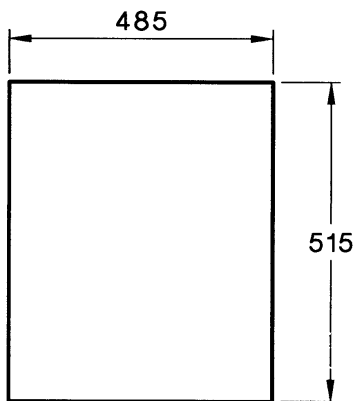

Front elevation

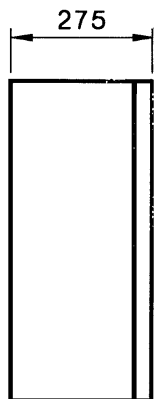

End elevation



Plan

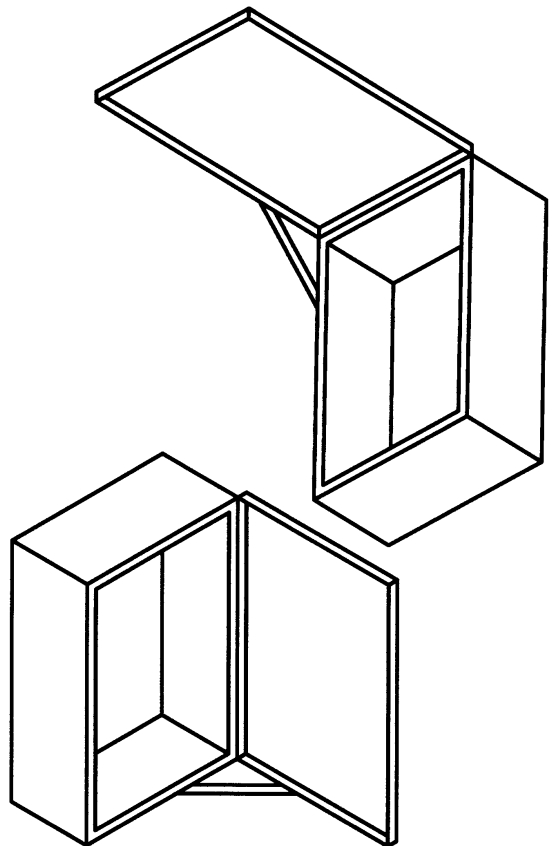

(b) Type II

Dimensions in millimetres

Figure A.2 (in part) — Typical meter enclosures and dimensions

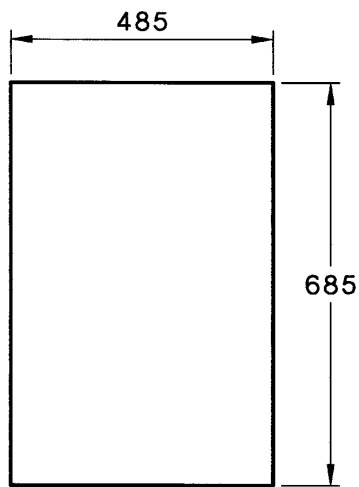

Front elevation

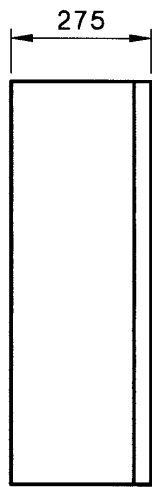

End elevation

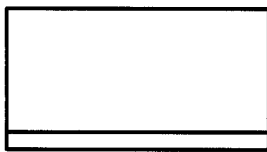

Plan

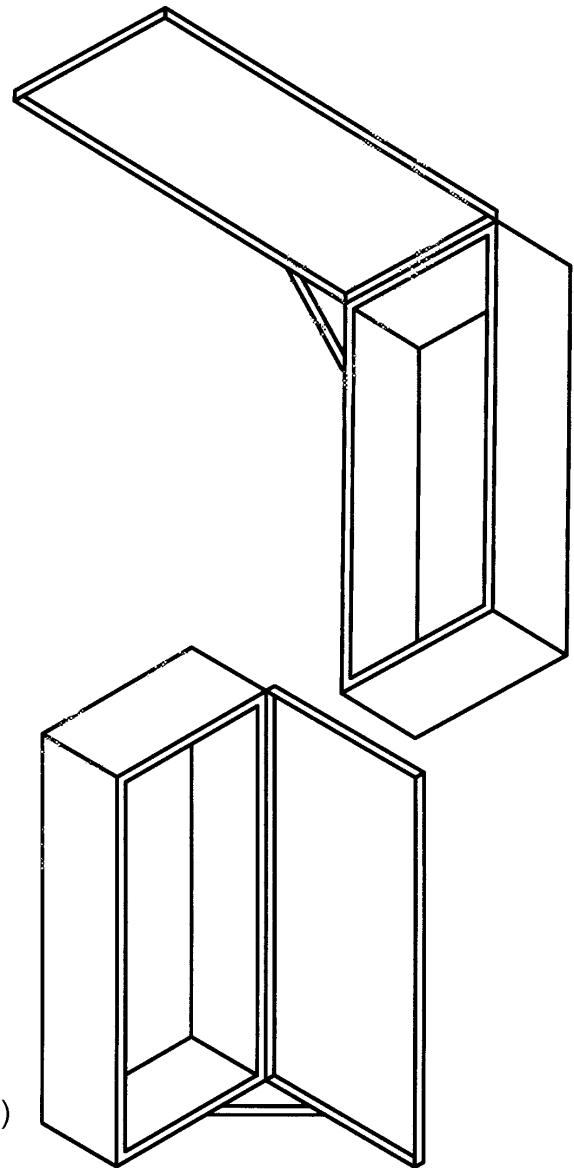

Dimensions in millimetres

Figure A.2 (in part) — Meter enclosures and dimensions

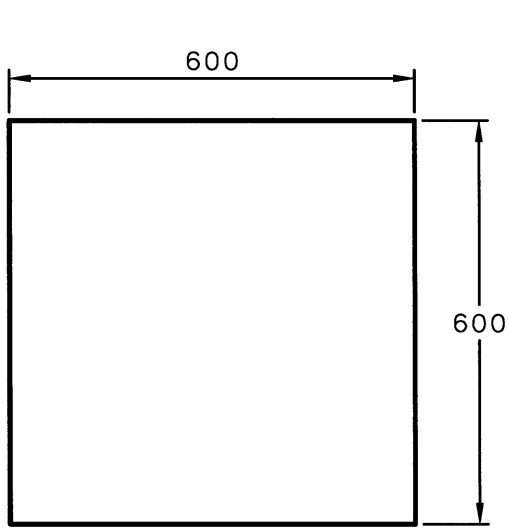

Front elevation

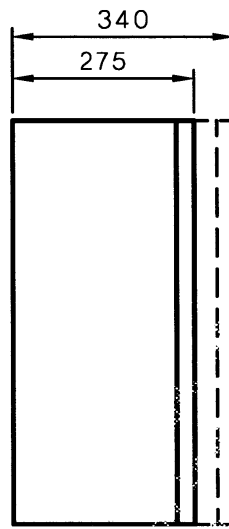

End elevation

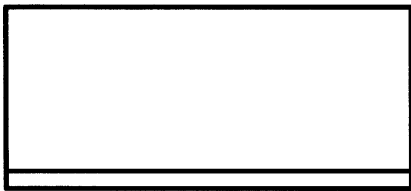

Plan

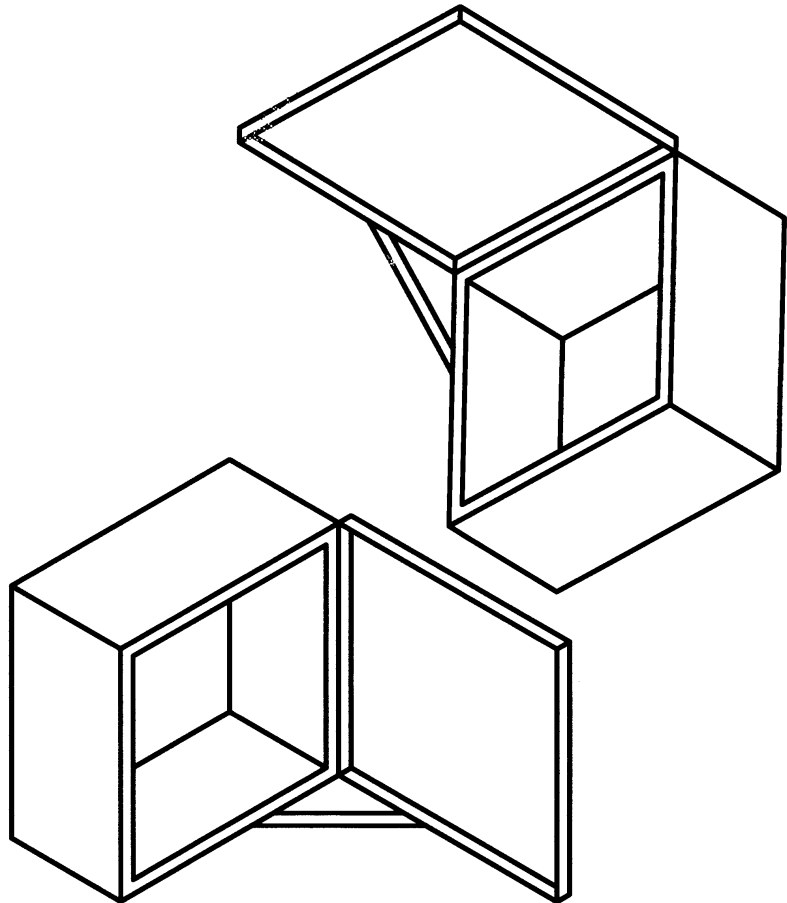

(d) Type IV

NOTE Alternative depth required for some installations (see KS 662).

Dimensions in millimetres

**Figure A.2 (in part) — Typical meter enclosures and dimensions**

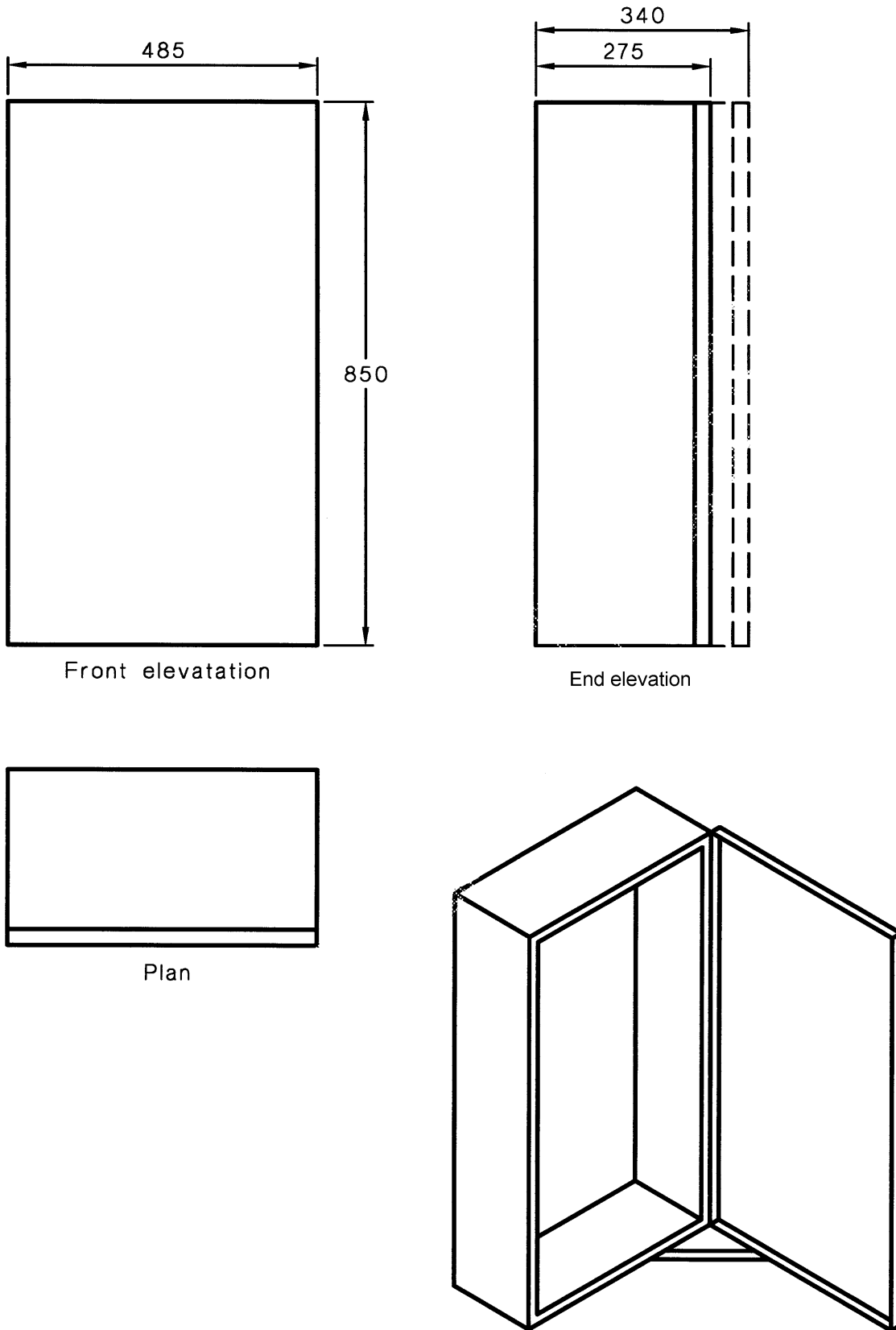

Front elevation

End elevation

Plan

(e) Type V

NOTE Alternative depth required for some installations (see KS 662).

Dimensions in millimetres

**Figure A.2 (in part) — Typical meter enclosures and dimensions**

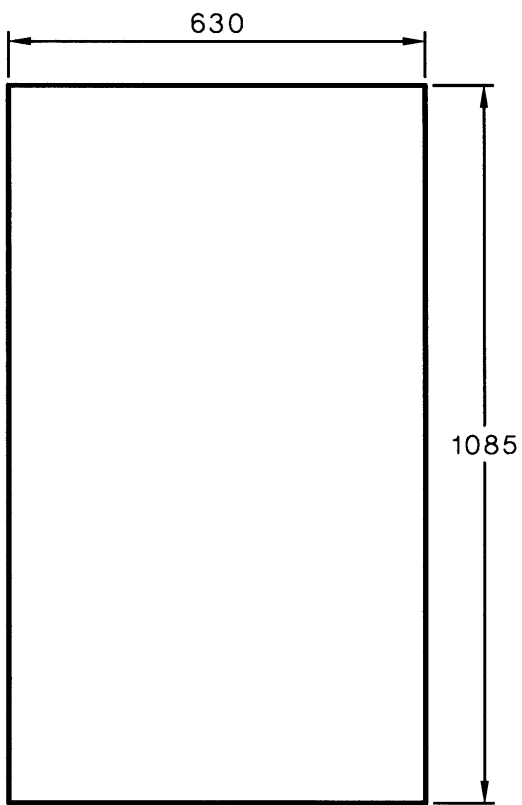

Front elevation

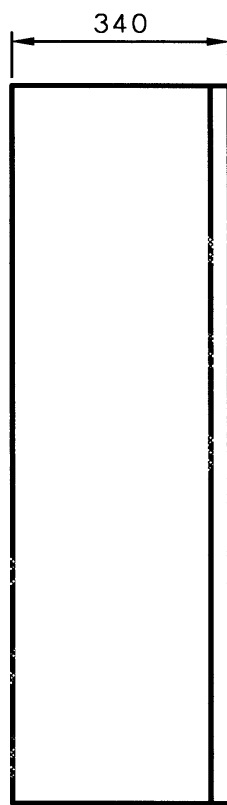

End elevation

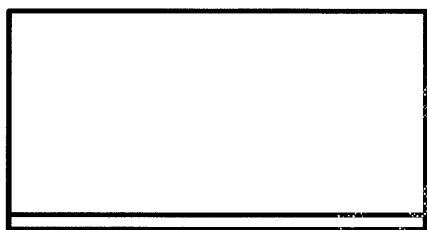

Plan

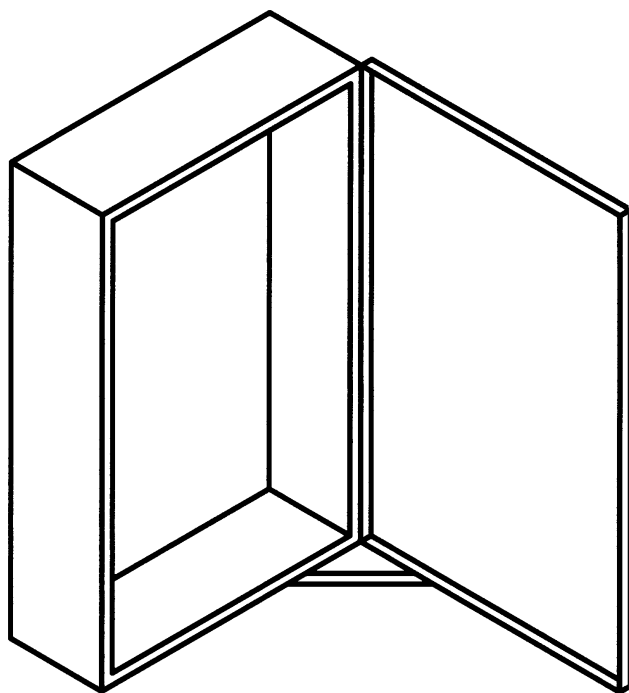

(f) Type VI

NOTE Alternative depth required for some installations (see KS 662).

Dimensions in millimetres

**Figure A.2 (in part) — Typical meter enclosures and dimensions**